

IRGP4050PbF

PDP Switch

Features

- Key parameters optimized for PDP sustain & Energy recovery applications
- 104A continuous collector current rating reduces component count
- High pulse current rating makes it ideal for capacitive load circuits
- Low temperature co-efficient of $V_{CE(ON)}$ ensures reduced power dissipation at operating junction temperatures
- Reverse voltage avalanche rating improves the robustness in sustain driver application
- Short fall & rise times for fast switching
- Lead-Free

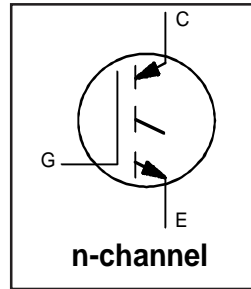

$V_{CES} = 250V$
$V_{CE(on) typ.} = 1.64V$
@ $V_{GE} = 15V, I_C = 30A$

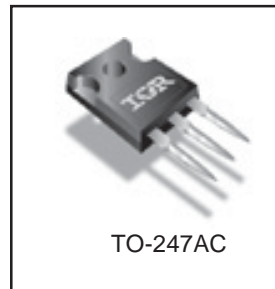

Description

This IGBT is specifically designed for sustain & energy recovery application in plasma display panels. This IGBT features low $V_{CE(ON)}$ and fast switching times to improve circuit efficiency and reliability. Low temperature co-efficient of $V_{CE(ON)}$ makes this IGBT an ideal device for PDP sustain driver application.

Absolute Maximum Ratings

	Parameter	Max.	Units
V_{CES}	Collector-to-Emitter Voltage	250	V
$I_C @ T_C = 25^\circ C$	Continuous Collector Current	104*	A
$I_C @ T_C = 100^\circ C$	Continuous Collector Current	56	
I_{CM}	Pulse Collector Current ①	208	
I_{LM}	Clamped Inductive Load current ②	290	
V_{GE}	Gate-to-Emitter Voltage	± 20	
E_{ARV}	Reverse Voltage Avalanche Energy ③	1240	mJ
$P_D @ T_C = 25^\circ C$	Maximum Power Dissipation	330	W
$P_D @ T_C = 100^\circ C$	Maximum Power Dissipation	130	
T_J	Operating Junction and Storage Temperature Range	-55 to +150	°C
T_{STG}			
	Solder Temperature Range, for 10 sec.	300 (0.063 in. (1.6mm) from case)	

Thermal / Mechanical Characteristics

	Parameter	Min.	Typ.	Max.	Units
$R_{\theta JC}$	Junction-to-Case- IGBT	—	—	0.38	°C/W
$R_{\theta CS}$	Case-to-Sink, flat, greased surface	—	0.24	—	
$R_{\theta JA}$	Junction-to-Ambient, typical socket mount	—	—	40	
Wt	Weight	—	6 (0.21)	—	g (oz.)

*Package limited to 60A.

Electrical Characteristics @ T_J = 25°C (unless otherwise specified)

Parameter	Min.	Typ.	Max.	Units	Conditions	
V _{(BR)CES}	250	—	—	V	V _{GE} = 0V, I _C = 250μA	
V _{(BR)ECS}	18	—	—	V	V _{GE} = 0V, I _C = 1.0A	
ΔV _{(BR)CES} /ΔT _J	—	8.2	—	mV/°C	V _{GE} = 0V, I _C = 1mA	
V _{CE(on)}	Collector-to-Emitter Saturation Voltage	—	1.64	1.90	V	I _C = 30A I _C = 56A I _C = 104A, T _J = 150°C V _{GE} = 15V See Fig. 2, 5
		—	2.04	—		
		—	2.60	—		
V _{GE(th)}	3.0	—	6.0		V _{CE} = V _{GE} , I _C = 250μA	
ΔV _{GE(th)} /ΔT _J	—	-11	—	mV/°C	V _{CE} = V _{GE} , I _C = 0.25mA	
g _{fe}	34	51	—	S	V _{CE} = 100V, I _C = 56A	
I _{CES}	Zero Gate Voltage Collector Current	—	—	250	μA	V _{GE} = 0V, V _{CE} = 250V
		—	—	2.0		V _{GE} = 0V, V _{CE} = 10V
		—	—	5000		V _{GE} = 0V, V _{CE} = 250V, T _J = 150°C
I _{GES}	—	—	±100	nA	V _{GE} = ±20V	

Switching Characteristics @ T_J = 25°C (unless otherwise specified)

Parameter	Min.	Typ.	Max.	Units	Conditions
Q _g	—	230	350	nC	I _C = 56A V _{CC} = 200V V _{GE} = 15V See Fig. 8
Q _{ge}	—	37	56		
Q _{gc}	—	78	120		
t _{d(on)}	—	37	—	ns	T _J = 25°C I _C = 30A, V _{CC} = 180V V _{GE} = 15V, R _G = 5.0Ω Energy losses include "tail" See Fig. 9, 10, 14
t _r	—	35	—		
t _{d(off)}	—	120	180		
t _f	—	59	89		
E _{on}	—	45	—		
E _{off}	—	125	—	μJ	
E _{TS}	—	170	—		
t _{d(on)}	—	35	—	ns	T _J = 150°C I _C = 30A, V _{CC} = 180V V _{GE} = 15V, R _G = 5.0Ω Energy losses include "tail" See Fig. 11, 14
t _r	—	35	—		
t _{d(off)}	—	130	—		
t _f	—	120	—		
E _{TS}	—	280	—		
L _E	—	13	—	nH	Measured 5mm from package
C _{ies}	—	4650	—	pF	V _{GE} = 0V V _{CC} = 30V, f = 1.0MHz See Fig. 7
C _{oes}	—	480	—		
C _{res}	—	92	—		

Notes:

- ① Repetitive rating; V_{GE} = 20V, pulse width limited by max. junction temperature. (See fig. 13b)
- ② V_{CC} = 80%(V_{CES}), V_{GE} = 20V, L = 10μH, R_G = 5.0Ω, (See fig. 13a).
- ③ Repetitive rating; pulse width limited by maximum junction temperature.
- ④ Pulse width ≤ 2.5ms; duty factor ≤ 0.1%.
- ⑤ Pulse width 5.0μs, single shot.

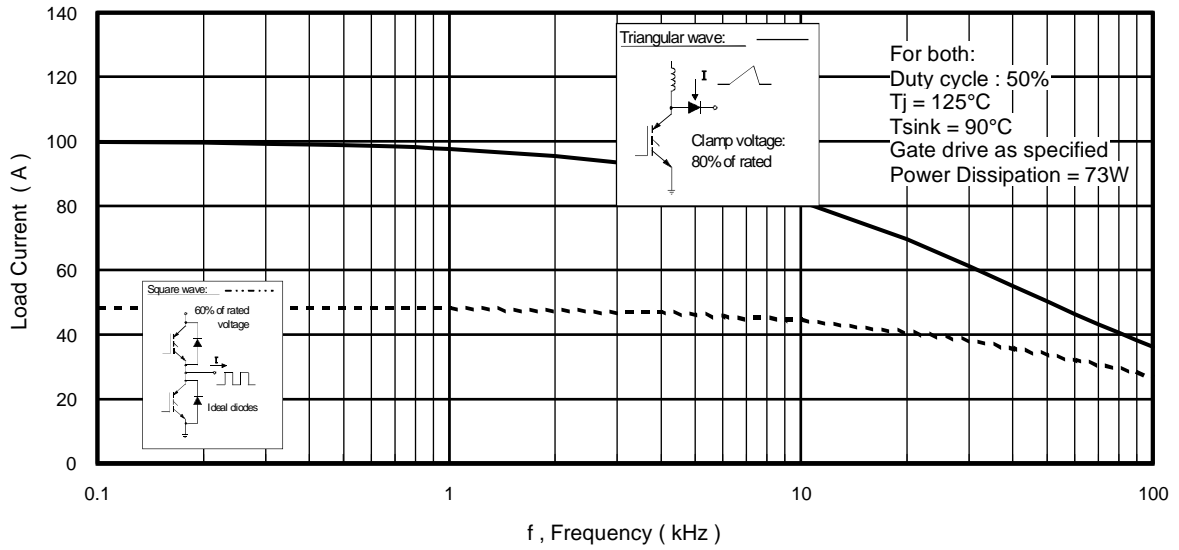

Fig. 1 - Typical Load Current vs. Frequency
(Load Current = I_{RMS} of fundamental)

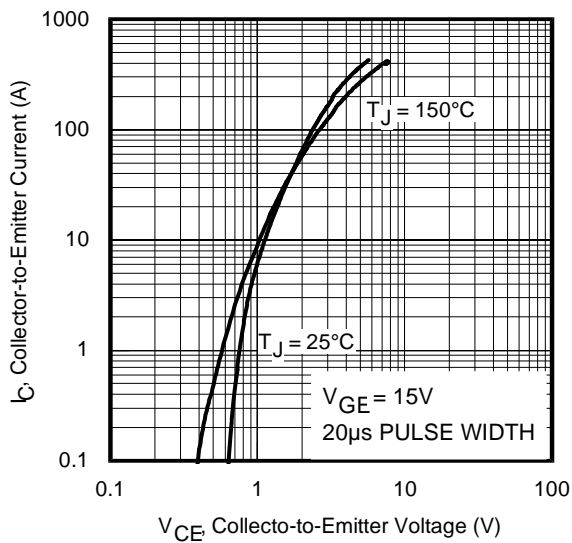

Fig. 2 - Typical Output Characteristics

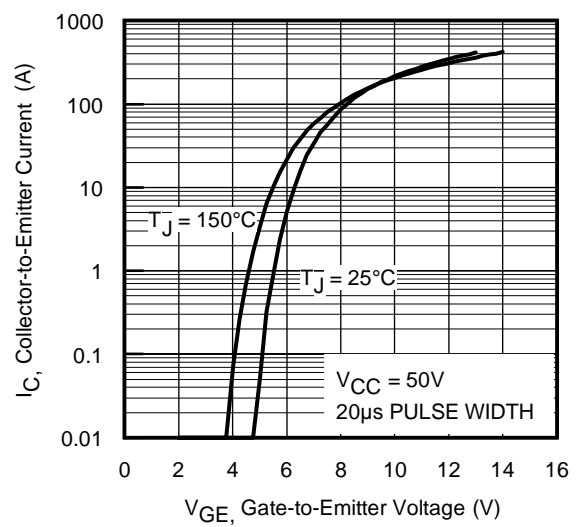

Fig. 3 - Typical Transfer Characteristics

IRGP4050PbF

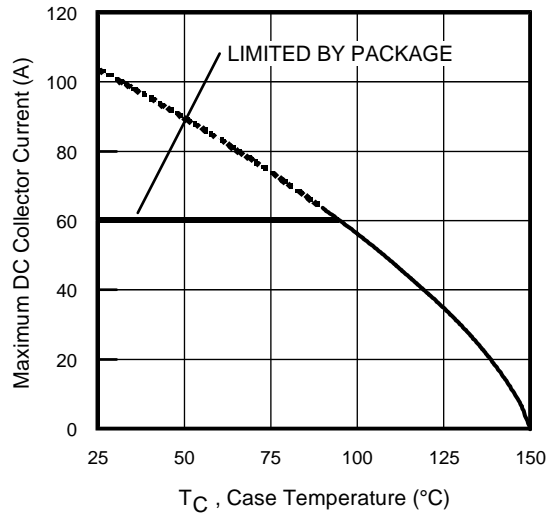

Fig. 4 - Maximum Collector Current vs. Case Temperature

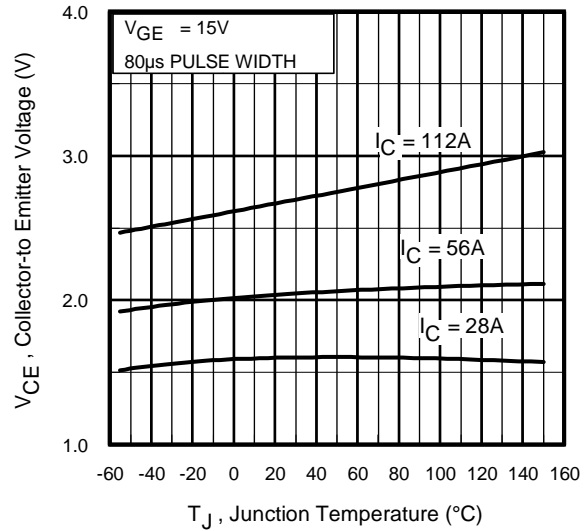

Fig. 5 - Typical Collector-to-Emitter Voltage vs. Junction Temperature

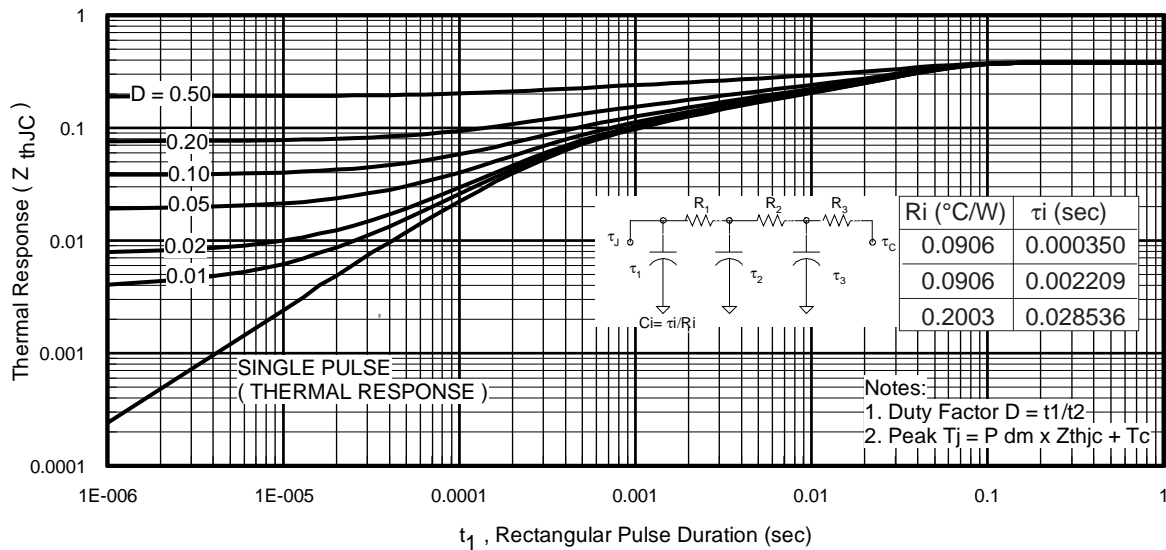

Fig. 6 - Maximum Effective Transient Thermal Impedance, Junction-to-Case

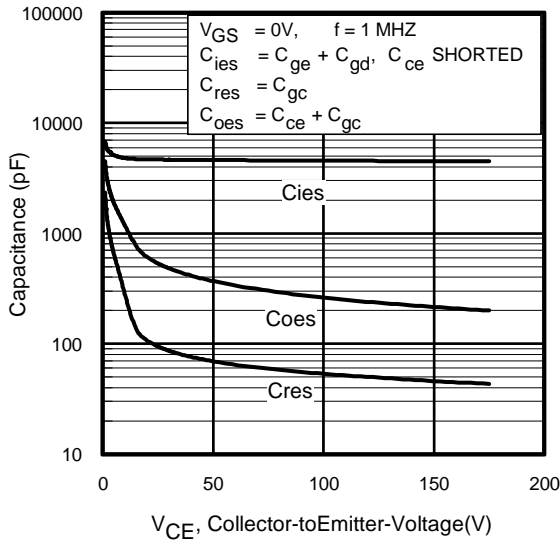

Fig. 7 - Typical Capacitance vs. Collector-to-Emitter Voltage

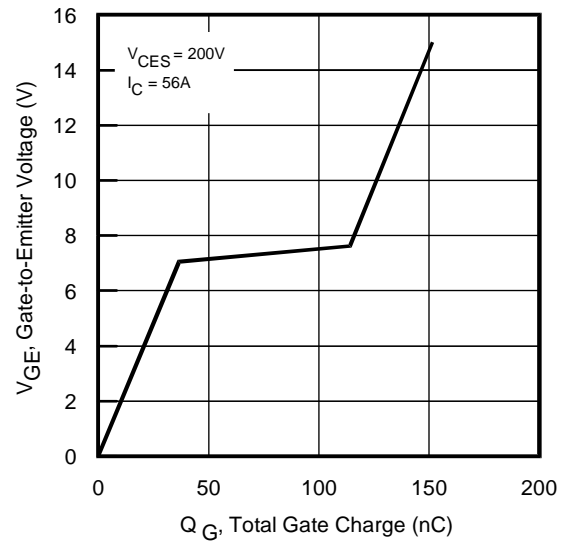

Fig. 8 - Typical Gate Charge vs. Gate-to-Emitter Voltage

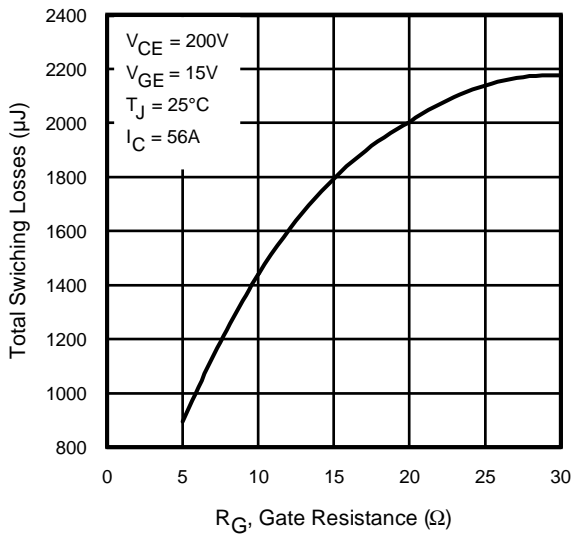

Fig. 9 - Typical Switching Losses vs. Gate Resistance

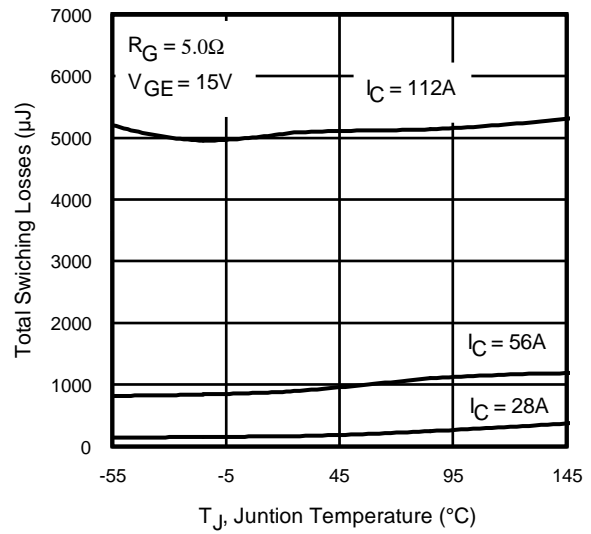

Fig. 10 - Typical Switching Losses vs. Junction Temperature

IRGP4050PbF

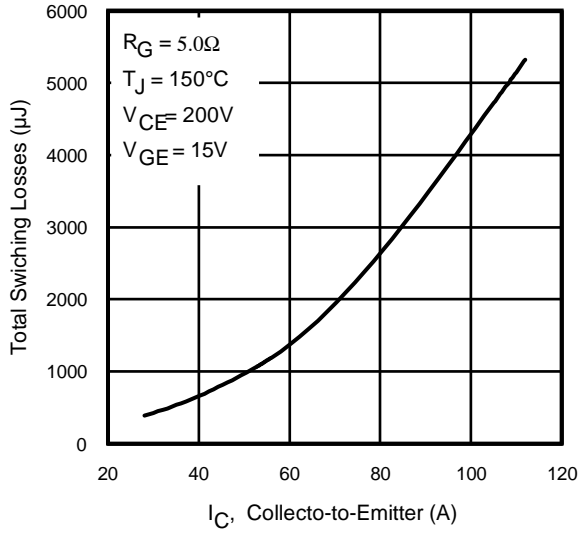

Fig. 11 - Typical Switching Losses vs. Collector-to-Emitter Current

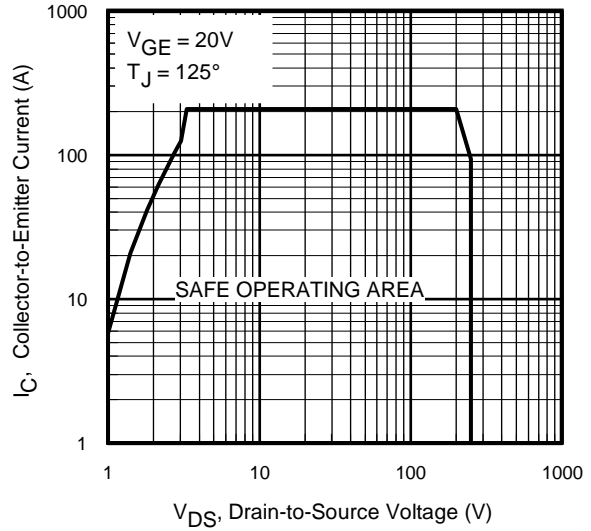

Fig. 12 - Turn-Off SOA

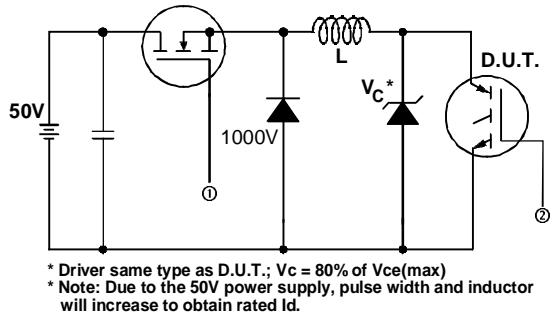

Fig. 13a - Clamped Inductive Load Test Circuit

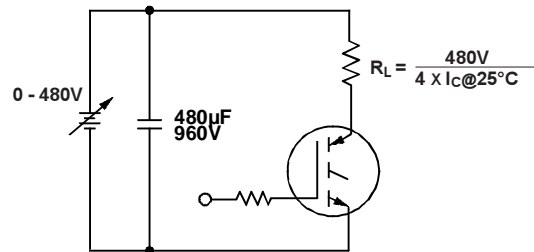

Fig. 13b - Pulsed Collector Current Test Circuit

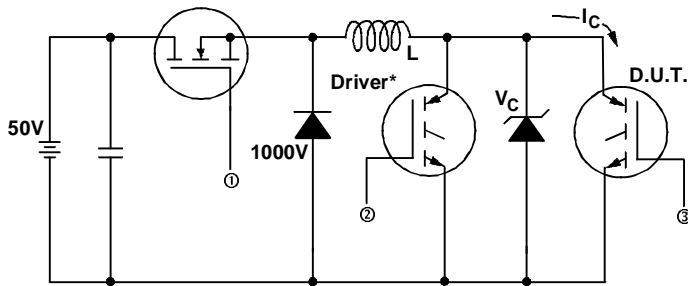

Fig. 14a - Switching Loss Test Circuit

* Driver same type as D.U.T., Vc = 480V

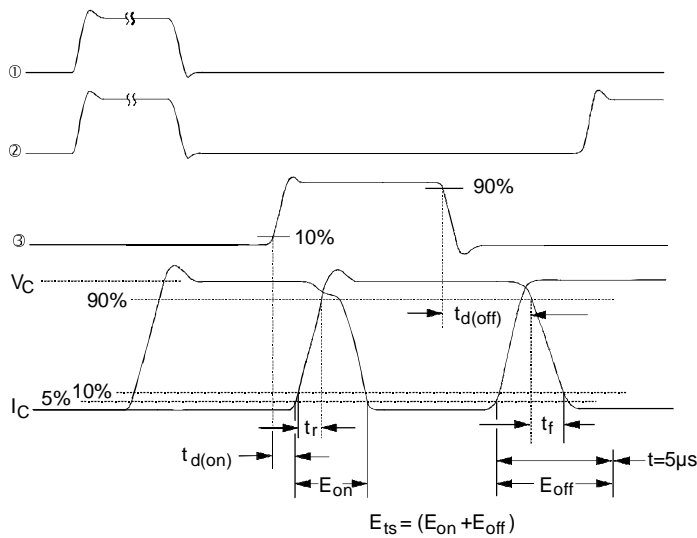
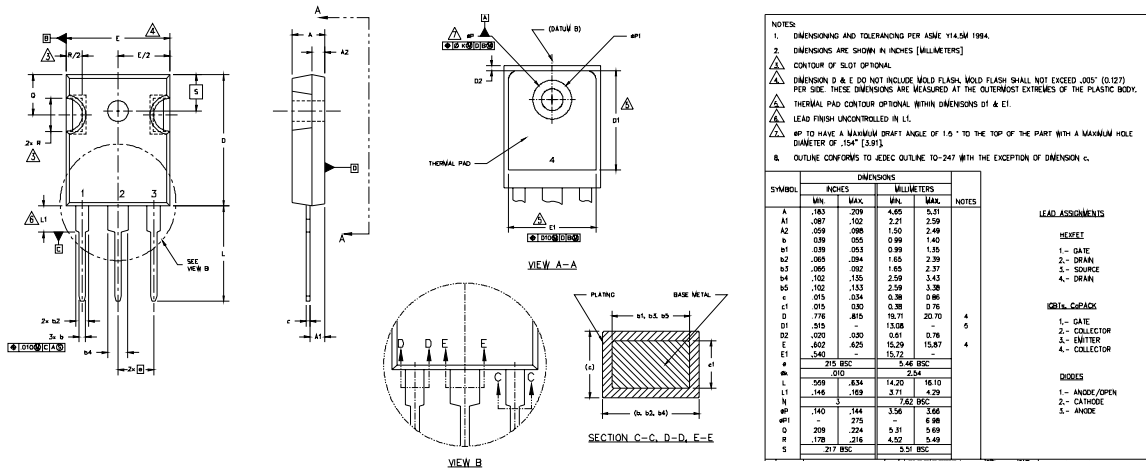

Fig. 14b - Switching Loss Waveforms

IRGP4050PbF

TO-247AC Package Outline

Dimensions are shown in millimeters (inches)



TO-247AC Part Marking Information

EXAMPLE: THIS IS AN IRFPE30
WITH ASSEMBLY
LOT CODE 5657
ASSEMBLED ON VV 35, 2000
IN THE ASSEMBLY LINE "H"

Note: "P" in assembly line
position indicates "Lead-Free"

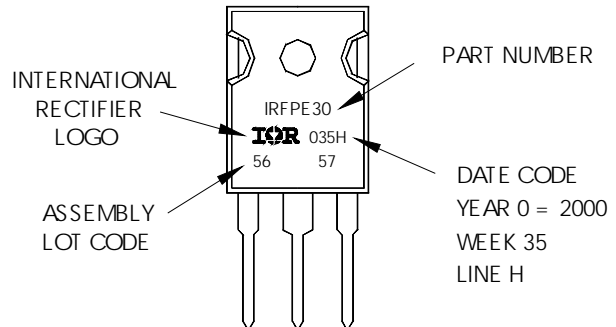

TO-247AC package is not recommended for Surface Mount Application.

Data and specifications subject to change without notice.
This product has been designed and qualified for the Industrial market.
Qualification Standards can be found on IR's Web site.



IR WORLD HEADQUARTERS: 233 Kansas St., El Segundo, California 90245, USA Tel: (310) 252-7105
TAC Fax: (310) 252-7903

Visit us at www.irf.com for sales contact information.08/04

Note: For the most current drawings please refer to the IR website at:
<http://www.irf.com/package/>